

Scope Vardi

The Vardi is a new collection offered in a surface mount multi-head or monopoint configuration. The monopoint derivative combines the Vardi 2" head with all the mounting features and finishes of the Scope Original 2.5" product. With integral and remote driver options we offer 9 standard mounting conditions including flangeless applications for wood ceilings (Panel Mount). If you need a mounting condition you don't see, just ask. The aluminum components, machined in New Jersey, allow for powder coat painting or anodize, opening our full pallet of 40 standard finishes plus the option for RAL# or custom paint match.

PROJECT:

TYPE:

SPECIFIER:

DATE:

Key Points (SCVM-RA)

Housing / Head

- US CSA listed to UL 1598 - damp rated
- Precision CNC machined aluminum in New Jersey
- 40 finish options + Custom/RAL#
- Multiple mounting options, including sloped ceilings
- Flanged (can be used in wood or GWB), Flangeless, or Panel Trim (millwork)
- Adjustable 360° degree rotation and 90° degree tilt

Source / Optics

- AmbientDim™, RGBW & Tunable White options
- 2700k, 3000k, 3500k, 4000K
- up to 748 delivered lumens
- <2 MacAdams Ellipses (<2 SDCM) for fixed white
- 90+ CRI, 60+ R9 for static white. 95+ CRI, 90+R9 for Ambient Dim
- 2 beam spreads - 15° and 30°
- [View Photometry](#)
- Compliant to with Airtight Housing

Driver / Control

- Drivers integral with fixture in some mounting options - see drawings
- TruPhase™ - Dim to 0.1% - 120V only
- Flicker free to IEEE 1789-2015 available with EldoLED or TruPhase™ selection
- Universal 120-277v

2" Round Z (Flangeless)



2" Round F (Flanged)

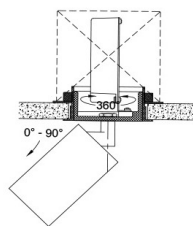
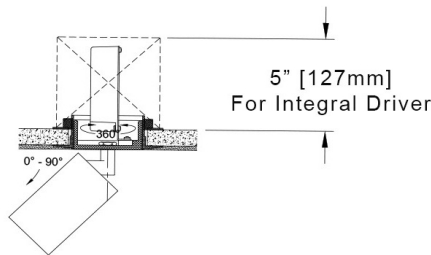
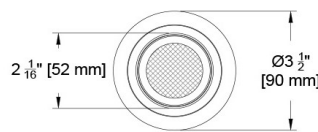
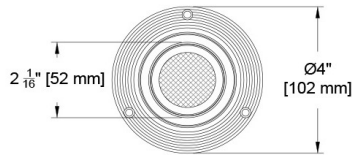

Ordering Codes

PROJECT:

SPECIFIER:

DATE:

TYPE:

QUANTITY:

Ordering Code Example: SCVM-RA-F-SM-C9-35-30-C1-A01-91L

FIXTURE	TRIM	MOUNTING	SOURCE / WATTS	CCT	BEAM	DRIVER / CONTROL	HEAD FINISH	ACCESSORIES
SCVM-RA								
Scope Vardi 2" Monopoint - Round	<p>Standard (2.5")</p> <p>F Flanged Trim</p> <p>Z Flangeless Trim</p> <p>Canopy (4")</p> <p>CP Canopy Plate for use with 4" Diameter Pancake Box/Octagonal Box</p>	<p>SM Surface Mount * †</p> <p>SMR Surface Mount ^ Δ</p> <p>SMHS - Surface Mount * † <i>furnished with Hang Straight</i></p> <p>SCSMR Sloped Ceiling Surface Mount ^ Δ <i>(furnished with Hang-Straight)</i></p> <p>SMLJB - Surface Mount † Large Junction Box</p> <p>PM Panel Mount * †</p> <p>PMR Panel Mount ^ Δ</p> <p>SCPM Sloped Wood Ceiling Panel Mount ^ †</p> <p>SCPMR Sloped Ceiling Panel Mount ^ Δ <i>(furnished with Hang-Straight)</i></p> <p>CM Canopy Mount Δ</p> <p>Shallow Panel Installation</p> <p>SHPM Shallow Panel Mount * Δ</p> <p>Retro-fit Installation</p> <p>SHM Shallow Surface Mount * Δ</p> <p>* Deep double gang Handy box supplied by others for driver enclosure ^ Double gang Handy box supplied by others for fixture mount and low voltage wiring † Integral Driver Δ Remote Driver</p>	<p>Citizen</p> <p>C5 ● ● 6W 484Lm* 90+CRI, 60+R9 Not compatible with C1, C2 drivers. Supports CA Title 24 when paired with all EldoLED</p> <p>C9 ● ● 9W 748Lm* 90+CRI, 60+R9</p> <p>Ambient Dim™</p> <p>A5 ● ● 6W 315Lm* 95+CRI, 90+R9 <i>Supports CA Title 24 when paired with all EldoLED and the Lutron</i></p> <p>A9 ● ● 10W 609Lm* 95+CRI, 90+R9</p> <p>● ● Supports CA Title 24 part 6 compliance to JA8 requirements</p> <p>*Based on 30° Beam</p> <p>View Photometry</p>	<p>27 2700K</p> <p>30 3000K</p> <p>35 3500K</p> <p>40 4000K</p> <p>Ambient Dim™</p> <p>3019 3000-1900K</p>	<p>15 Spot</p> <p>30 Narrow Flood</p>	<p>C1 0-10 ^ + 1.0%, UNV (120-277V) linear</p> <p>C2 ELV/Triac ^ + 1.0%, (120-277V) linear</p> <p>E1 0-10* 0.1%, UNV (120-277V) log</p> <p>E2 DALI-2* 0.1%, UNV (120-277V) log</p> <p>E3 0-10* 0.1%, UNV (120-277V) linear</p> <p>E4 * DMX 0.1%, UNV (120-277V) Universal DMX Driver/Controller RGBWW-DMX <i>(INCLUDES DMX/RDM COMPATIBLE DRIVER WITH BUILT-IN DECODER - CONTROLLER BY OTHERS)</i></p> <p>TR2 TruPhase™ 0.1%, (120-120V) log Up to 20W Forward and Reverse compatible Phase Dimming Static White & Ambient Dim only</p> <p>LD Digital Ecosystem* 1.0%, UNV (120-277V) ECO Hi-Lume SoftOn/Fade-to-Black LDE1</p> <p>* Requires remote mounting ^integral driver standard, remote optional</p> <p>+ Not compatible with C5 source.</p>	<p>B Black Paint</p> <p>W White Paint^</p> <p>PXX Specialty Paint Color*</p> <p>B05 Satin Brass^</p> <p>BXX Brass Finishes^</p> <p>B01-B07</p> <p>^Stem comes in selected color</p> <p>* See Finish Guide</p>	<p>Reflector (lamp) Media</p> <p>91L Solite*</p> <p>97L Black Hexcel Louver*</p> <p>XXL Other Reflector (lamp) Media*</p> <p>Other</p> <p>STM Standard length 3/8" For custom size, indicate in inches</p> <p>Controls</p> <p>LR Lutron Wireless RF PowPak</p> <p>ATH Lutron Athena Wireless Node <i>Must be used with E2 driver (DALI-2)</i></p> <p>CA Casambi Wireless BLE to be paired with driver</p> <p>*see Lens Guide</p>

Ceiling Cutouts and Dimensions

Flangeless Monopoint (Integral Driver)

Plaster Surface Mount (SM)

Integral Driver

(SCVM-RA-Z-SM-)

See *Integral Driver Detail Page* for recessed depth and j-box configurations by driver type.

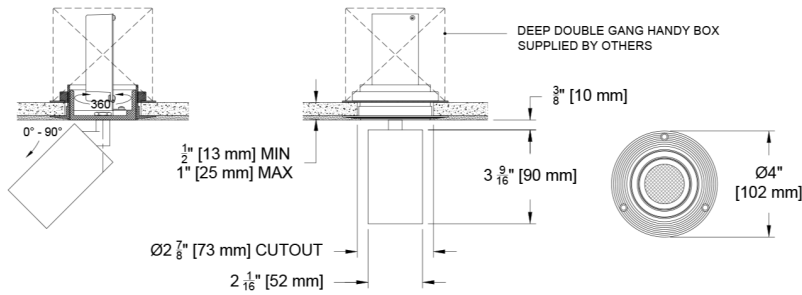

Flanged Monopoint (Integral Driver)

Flanged Surface Mount (SM)

(SCVM-RA-F-SM-)

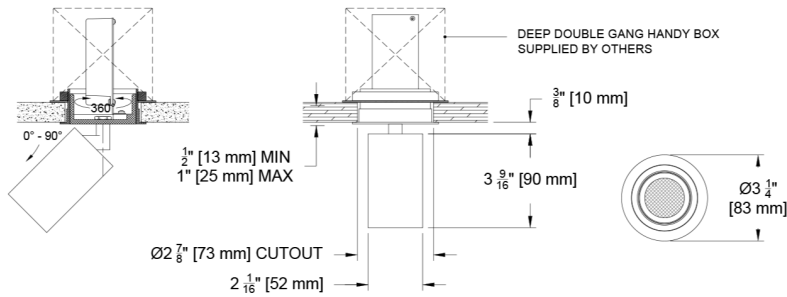

Flangeless Monopoint (Integral Driver)

Panel Mount (PM)

(SCVM-RA-Z-PM-)

Panel Mount Detail

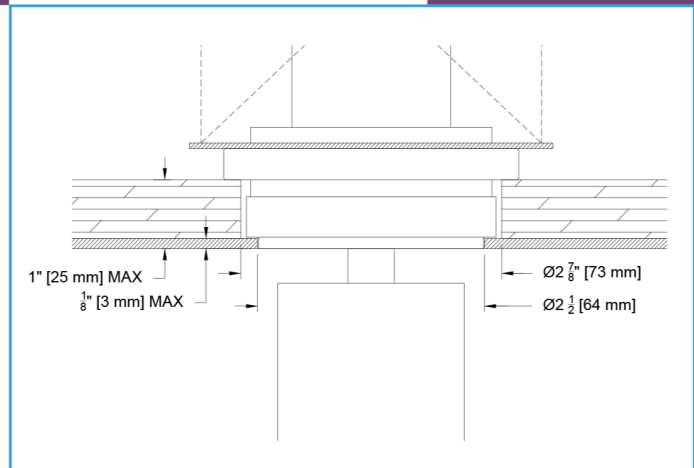
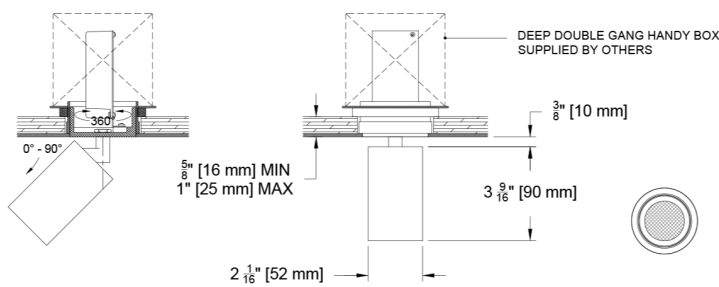

Ceiling Cutouts and Dimensions

Flangeless Monopoint (Remote Driver)

Plaster Surface Mount (SMR)

(SCVM-RA-Z-SMR-)

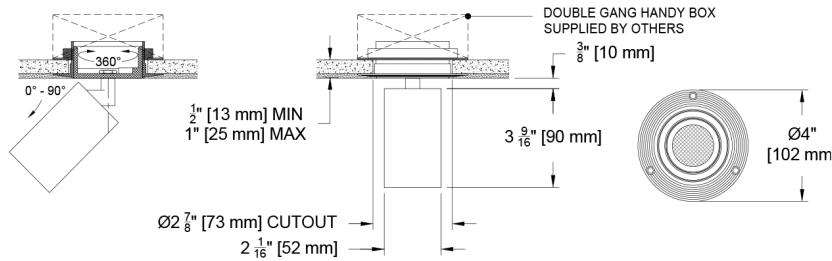

Remote Driver Box

for C1, C2, E1, E2, E3, TR2

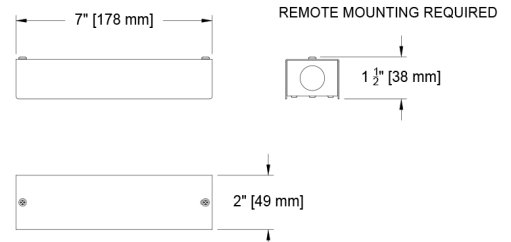

Remote Driver Box

for E4, LD

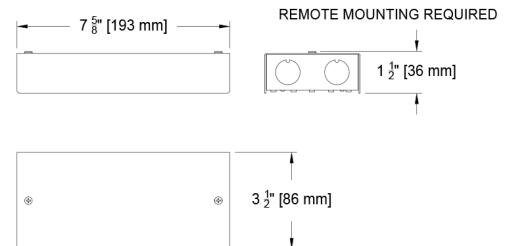

Flanged Monopoint (Remote Driver)

Flanged Surface Mount (SMR)

(SCVM-RA-F-SMR-)

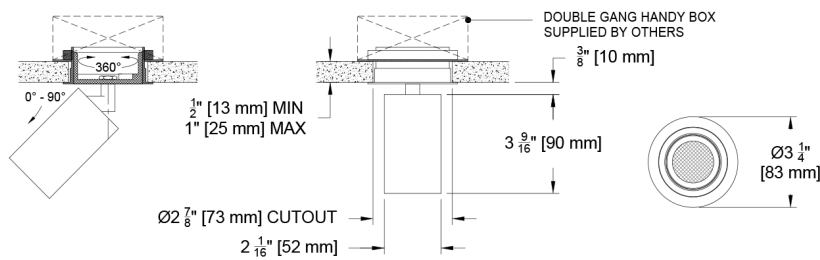

Flangeless Monopoint (Remote Driver)

Panel Mount (PMR)

(SCVM-RA-Z-PMR-)

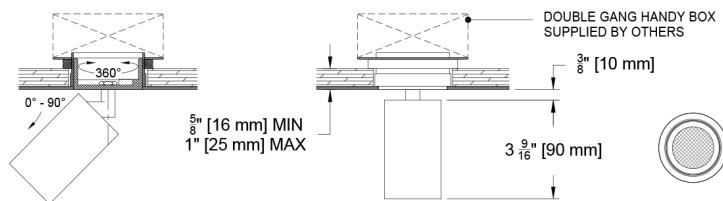

Panel Mount Detail

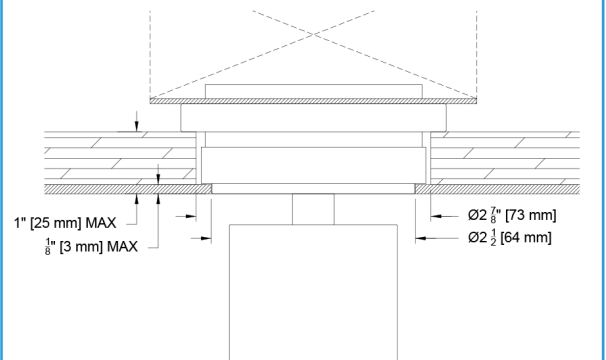

Ceiling Cutouts and Dimensions

Flangeless Monopoint (Remote Driver)

Plaster Retro-fit / Shallow Surface Mount (SHM)

(SCVM-RA-Z-SHM-)

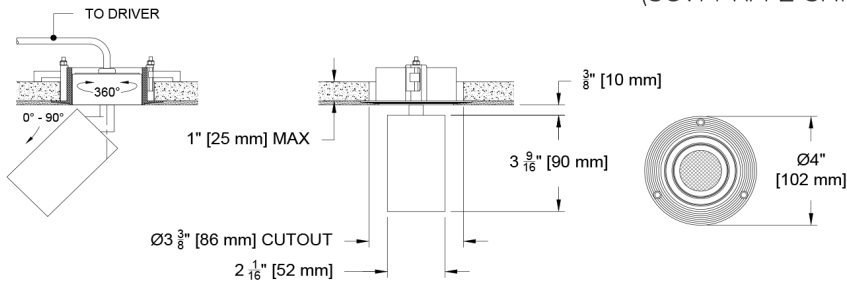

Remote Driver Box

for C1, C2, E1, E2, E3, TR2

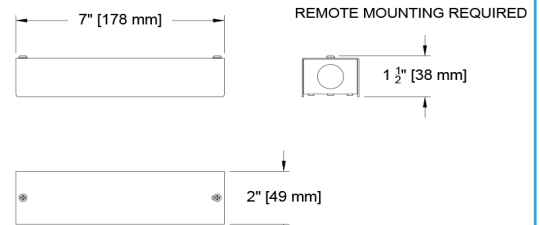

Flanged Monopoint (Remote Driver)

Flanged Retro-fit / Shallow Surface Mount (SHM)

(SCVM-RA-F-SHM-)

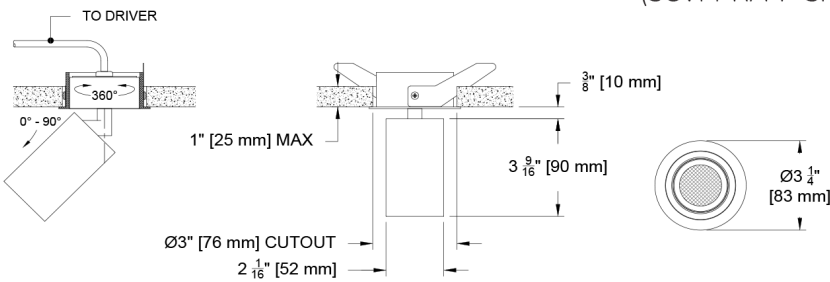

Remote Driver Box

for E4, LD

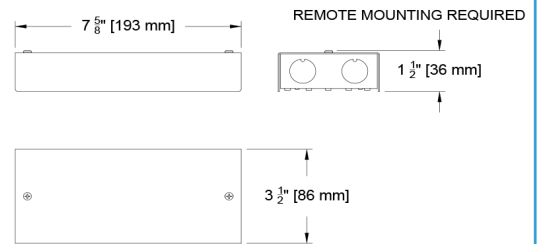

Flangeless Monopoint (Remote Driver)

Panel Mount Retro-fit / Shallow Panel Mount (SHPM)

(SCVM-RA-Z-SHPM-)

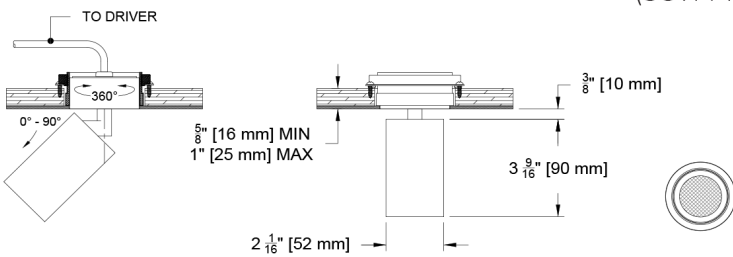

Panel Mount Detail

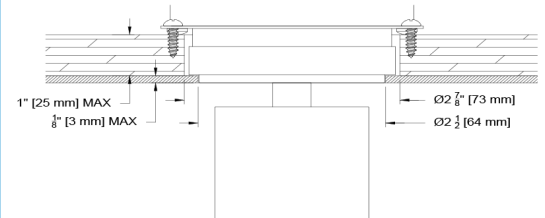

Canopy Plate (Remote Driver)

Canopy Mount (CP-CM)

(SCVM-RA-CP-CM-)

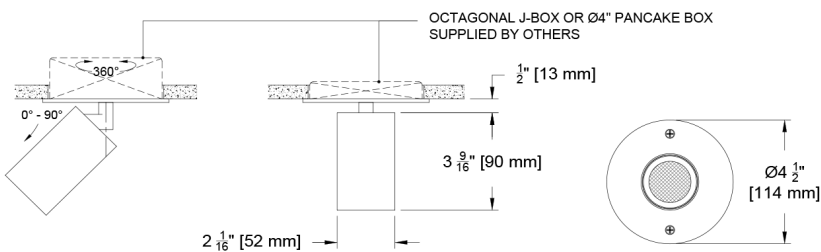

Ceiling Cutouts and Dimensions

Flangeless Monopoint (Remote Driver) Plaster Surface Mount Sloped Ceiling Remote Driver (SCSMR-) (SCVM-RA-Z-SCSMR-)

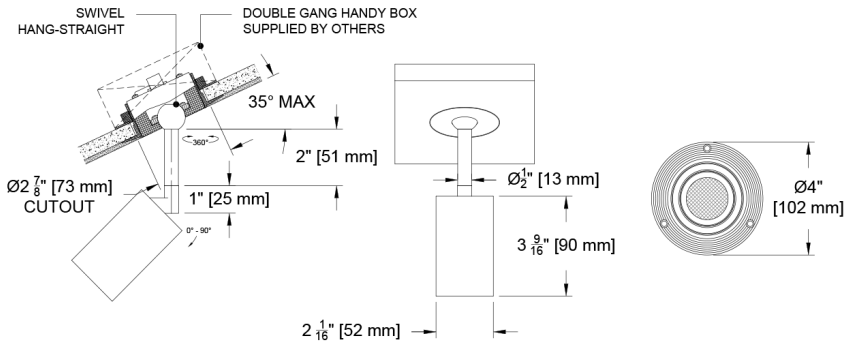

Remote Driver Box for C1, C2, E1, E2, E3, TR2

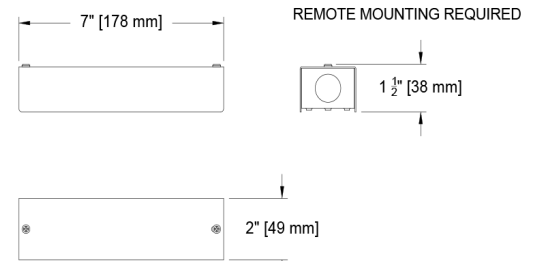

Remote Driver Box for E4, LD

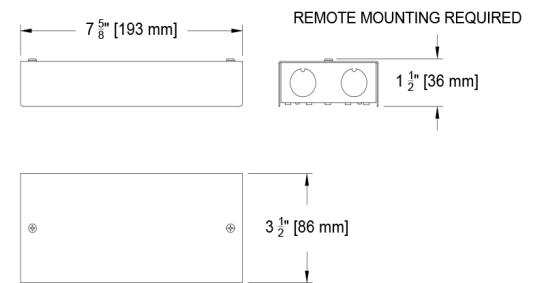

Flanged Monopoint (Remote Driver) Flanged Surface Mount Sloped Ceiling Remote Driver (SCSMR-) (SCVM-RA-F-SCSMR-)

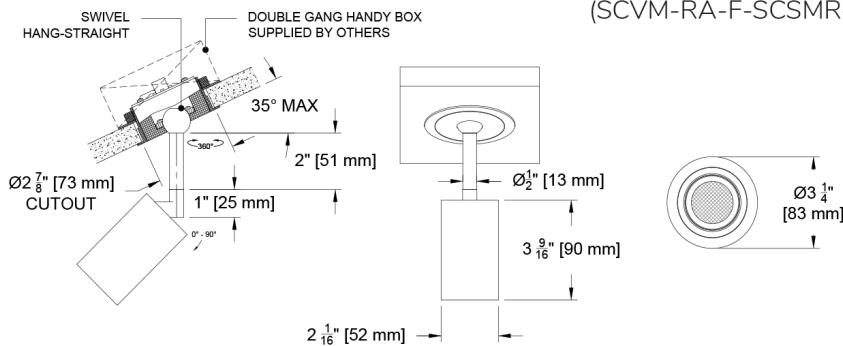

Flangeless Monopoint (Remote Driver) Panel Mount Sloped Ceiling Remote Driver (SCPMR-) (SCVM-RA-Z-SCPMR-)

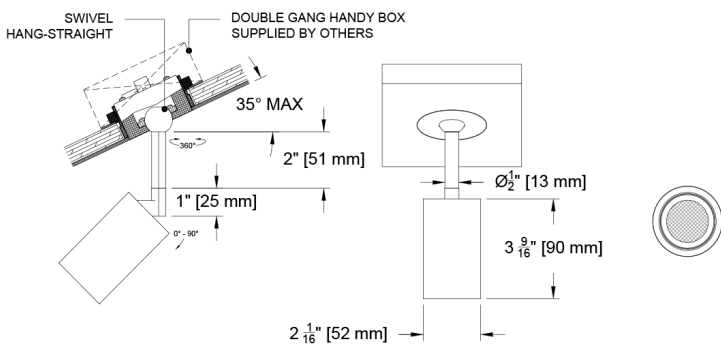

Panel Mount Detail

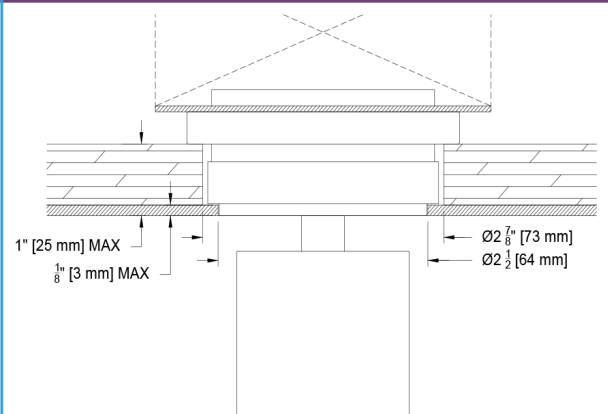

Ceiling Cutouts and Dimensions

Surface Mount (Integral Driver)

Large J-Box

(SCVM-RA-Z-SMLJB-)

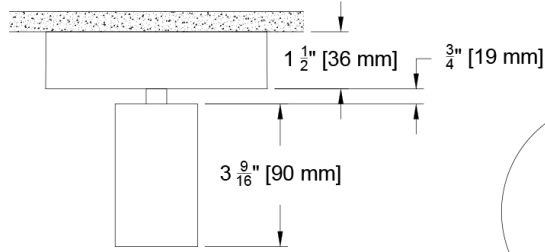
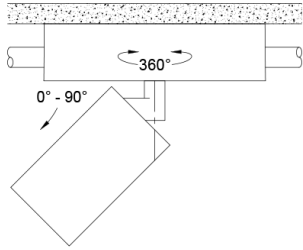

Integral Driver Details

Integral Driver J-Box Configuration

for C1, C2 Drivers

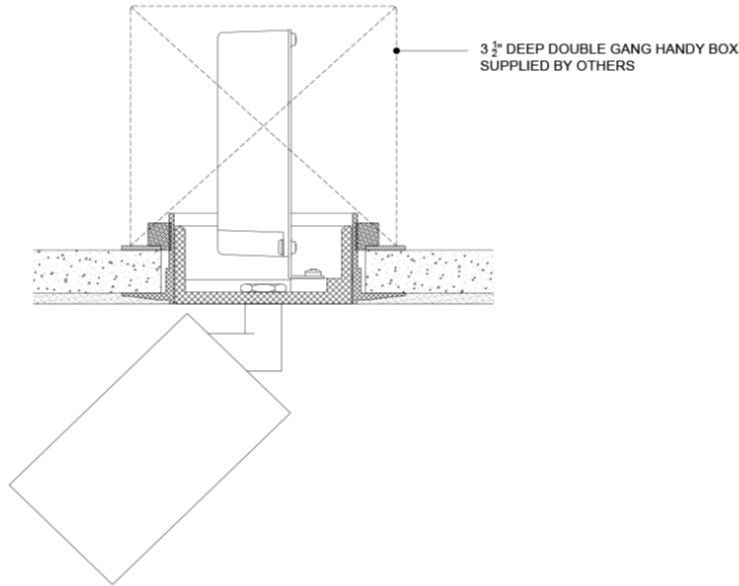

Inegral Driver J-Box Configuration

for E1, E2, E3, LP Drivers

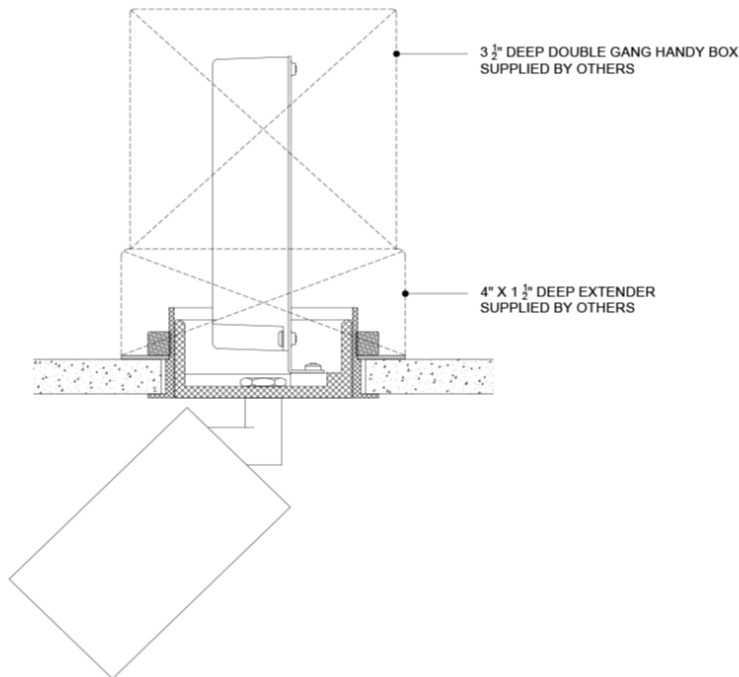

Photometric Table

All data below are delivered lumens based on goniometer measurements of production representative product. All lumen values can vary +/- 10% from LED manufacturer rated nominal flux. ISO CD plots based on C9 source. UGR only applicable in straight down position.

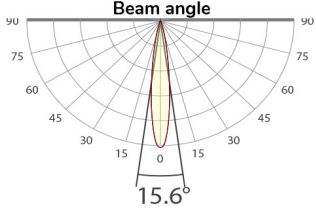
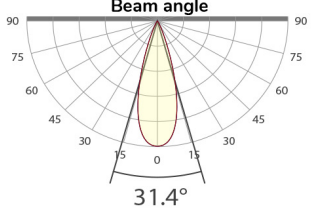
Beamspreads		15°					30°				
	System watts (W)	Delivered Lumens (lm)	Lumens/ Watt	UGR	Peak CD	10% Field	Delivered Lumens (lm)	Lumens/ Watt	UGR	Peak CD	10% Field
Citizen C5	6	462	77	6	4939	29°	464	76	8	1549	49°
Citizen C9	9	707	79	10	6374	32°	748	84	10	2500	50°
Ambient Dim A5	6	311	52	8	2829	31°	315	52	6	985	50°
Ambient Dim A9	10	599	59	9	3633	40°	609	60	9	2051	50°
CCT Multiplier											
CCT	Citizen										
2700	0.95										
3000	1.00										
3500	1.02										
4000	1.03										

Color Data

All data below are delivered lumens. Color and flux information based on goniometer measurements of production representative product. All values can vary +/- 10% from LED manufacturer data range as listed on their datasheet.

Citizen Source C5, C9

- <2 MacAdam Ellipse (<2 SDCM)
- 90+ CRI and RF
- 60+R9, Hue Bin 1

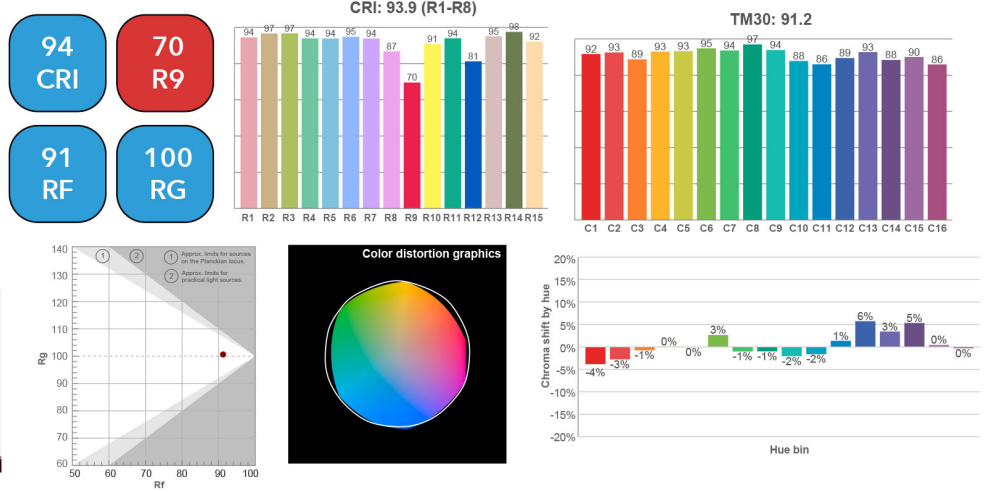

Ambient Dim Source - A5, A9 (AD - 3000k to 1900k)

- <3 MacAdam Ellipse (<3 SDCM)
- 95+ CRI and RF
- 90+R9, Hue Bin 1
- Follows Black Body Locus through dimming range

3000 CCT Full Output

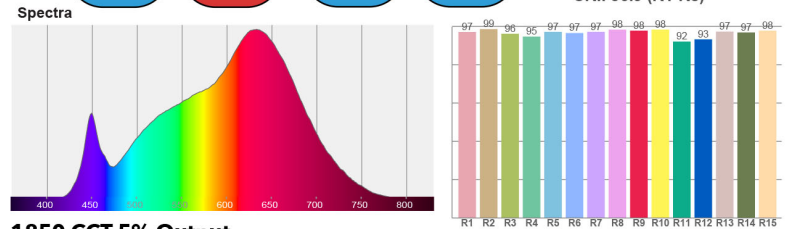

1850 CCT 5% Output

